

# AURORA SHELVING PLANNING GUIDE

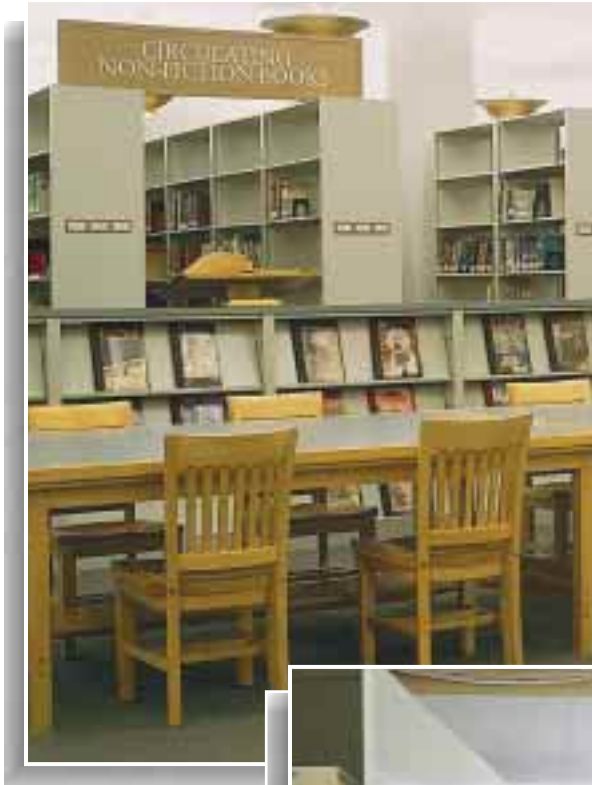

# TABLE OF CONTENTS

THE AURORA SHELVING CONCEPT .....	1
Easy 5-Minute Assembly .....	2
The Aurora Shelving Family .....	3
Part Numbering System for All Aurora Products .....	3
The Advantages of Aurora Shelving .....	4
Upright Styles .....	4
AURORA HEAVY DUTY SHELVING .....	5
Aurora Heavy Duty Specifications .....	6
Aurora Heavy Duty Accessories .....	7, 8
Aurora Storage System with Wood Shelves .....	9
Ordering Information .....	10
AURORA LIBRARY SHELVING .....	11
Selection Guide for Aurora Library .....	11
Aurora Library Specifications .....	12
Aurora Library Accessories .....	13
AURORA SHELF FILING & X-RAY SHELVING .....	14
Selection Guide for Aurora Shelf Filing .....	15
Aurora X-Ray Shelving .....	15
Aurora Filing Specifications .....	16
Aurora Shelf Filing .....	17
Floor Loading Guidelines .....	18
Shelving Adjustability Chart .....	18
Filing Inch / Square Footage Comparison Chart .....	19

# INNOVATIONS IN STORAGE SYSTEMS

Storage almost always costs money rather than making money. But storage is a necessity. The age old problem is how to do the job most efficiently. Since 1915 Aurora Shelving has met this problem head-on with continuing innovations in quality products which today comprise a complete storage system.

Aurora Shelving is unique in its advantages to you whether you store files, books, industrial products, or office materials.

The total value of Aurora Shelving products is found in its considerable savings in assembly time. Its outstanding strength permits heavier loading for greater utilization of space. A clean line design makes it easy to store and remove materials giving you an attractive installation. In other words, Aurora Shelving attacks your two greatest storage costs — **labor** and **space**.

---

## THE AURORA SHELVING CONCEPT

### Three basic parts form a system of storage units

This concept is the basis for the products in the full line of Aurora Shelving storage systems.

The strength and economics of the Aurora Shelving design have been proven over the years in thousands of installations.

Using this concept, storage systems have been reduced to their simplest form.

Each unit is a combination of uprights, shelves, and shelf supports- just three basic parts. This greatly simplifies construction and reduces inventory costs. Another advantage is the complete interchangeability of many parts among various types of Aurora Shelving Products storage units.

Parts are available to give added flexibility to Aurora Shelving units. These include shelf reinforcements, closed uprights, backs, doors and **Quik-Base™** to enclose each shelving unit. All of these can be installed by hand without nuts or bolts.

The advantages of the Aurora Shelving concept apply to all of the units detailed in this manual: Aurora Heavy Duty Shelving, Aurora Library Shelving, Aurora Shelf Filing and Aurora X-Ray Shelving.

1 UPRIGHT. (open "T", or open "L" formation). Each post has a double wall of steel with holes punched on the inner wall only. Exposed face is without holes and flush with shelf. "T" post is 2" wide, with 2 rows of holes for common post construction. The "L" post is 1" wide with 1 row of holes for end post or unit-type construction.

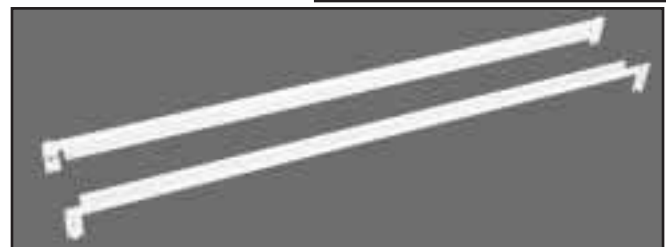
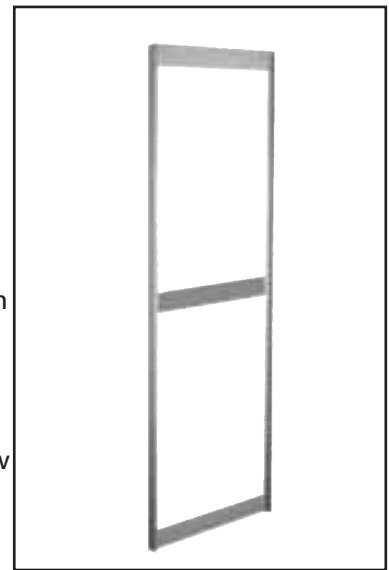

2 SHELF SUPPORTS. Provide full width support under each shelf, front and back. Rivets on support fit into holes punched on the inner wall of upright posts.



3 SHELF. Shelves fit over shelf supports. No fastening required.

# Easy 5-Minute Assembly...

fastest of all shelving... no hand tools needed... no sway braces, nuts, bolts, or clips.

Actual time reported by one user for a three-man crew to erect Aurora Shelving is: 42 sections, each with 9 shelves, per hour. Another user reports an 85% savings in installation costs compared to conventional nut and bolt shelving; 30% savings compared to clip or stud types. These reductions in time and cost apply to all Aurora Shelving storage units.

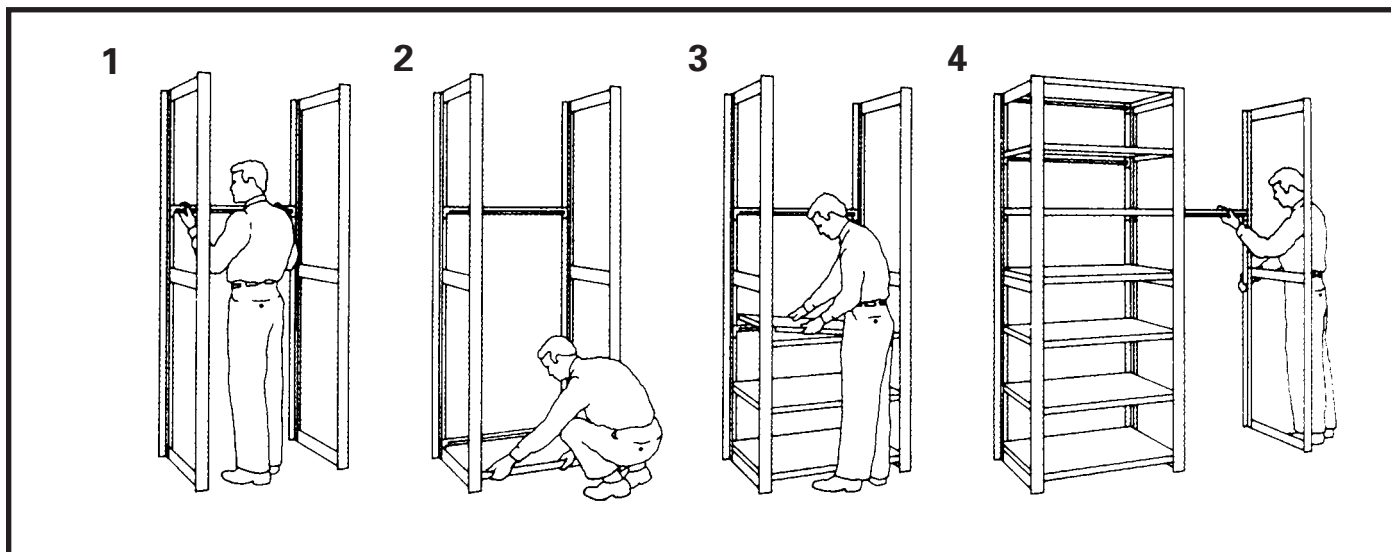

**1.** Position uprights. Temporarily place one shelf support at any convenient location to properly space uprights.

**2.** Build from the bottom up. Place shelf supports (front and back) for lowest shelf only.

**3.** Fit shelf over supports. Then add two more supports at the next shelf location ...place shelf...continue up the unit.

**4.** Add extra sections. Utilize common center uprights. (An additional upright must be used to add extra sections)

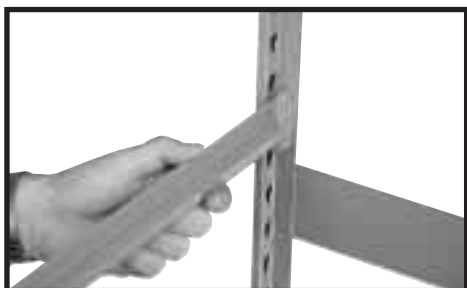

Rivets on shelf supports fit into holes punched on inner wall of upright posts.

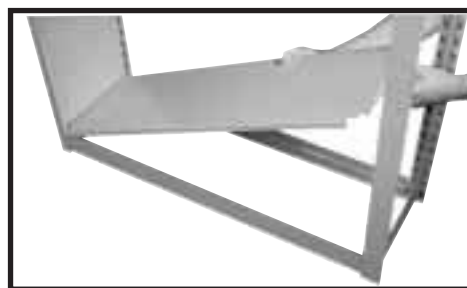

Shelves fit over shelf supports, quickly and easily.

# THE AURORA SHELVING FAMILY



**Aurora Heavy Duty Steel Shelving** meets all types of storage needs for materials of all sizes and weights. Fastest assembly. Greatest strength.



**Aurora Library Shelving** brings attractiveness, strength and maximum visibility to book storage. No nuts, bolts, clips, or sway braces to snag books.



**Aurora Shelf Filing** provides maximum storage in minimum space for economical, easy access open-shelf filing. 8 openings in 88<sup>1</sup>/<sub>4</sub>" high section.



**Aurora X-Ray Shelving** designed to eliminate nuts, bolts, clips, and sway braces that might snag X-Ray Folders. Easily withstands heavy loading of X-Rays.

## THE AURORA SHELVING FAMILY OF STORAGE UNITS

All Aurora Shelving storage units give you these advantages: 1. Fast, easy assembly. 2. Heavy duty strength. 3. Modern, straight-line appearance.

No matter what your storage application, there's a unit ready to bring you the greatest efficiency in handling and storage at the lowest total cost. When you consider the assembly cost savings and versatility of Aurora Shelving products, their total value advantages make them the only choice over conventional shelving.

### PART NUMBERING SYSTEM FOR ALL AURORA PRODUCTS

The Part Numbering System for all Aurora Shelving products describes the individual components or assemblies in complete detail. This system helps simplify your ordering, eliminates descriptions, and provides a visual check on size related parts. Following are general rules:

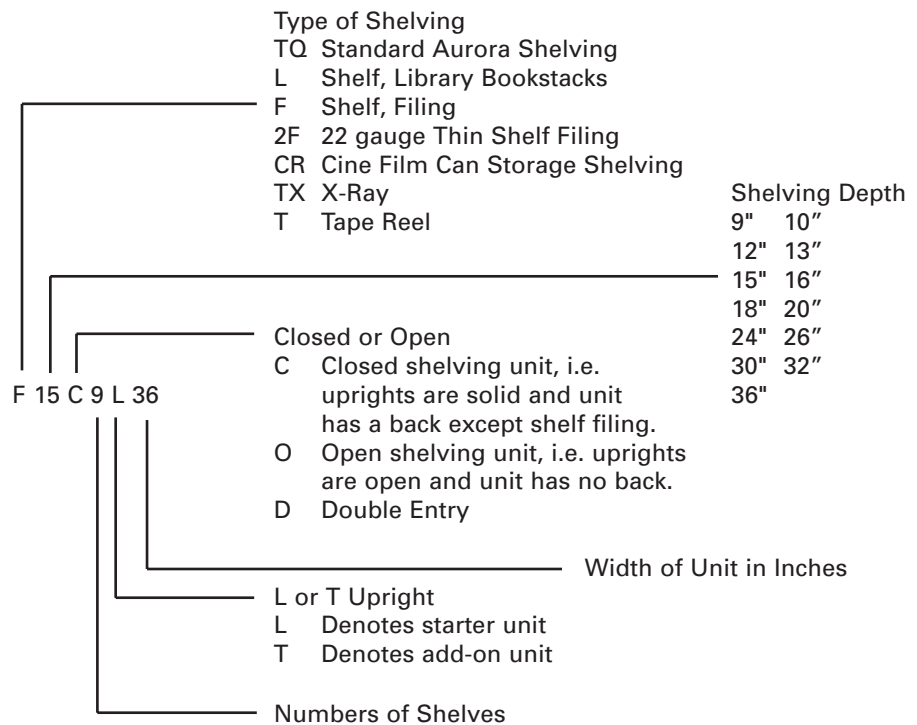

# COMPARE THE MANY ADVANTAGES OF AURORA SHELVING

## AURORA SHELVING

- **Rigidity without sway braces** provides access from all sides and faster assembly. Excellent for double entry storage. Cleaner appearance, too.
- **No clips, studs, nuts, or bolts.**  
Rivets quickly lock into keyhole slots, and shelves adjust on 1-1/2" centers.
- **Full-width shelf supports**  
Unmatched strength and load-bearing capacity.
- **Accepts chipboard or plywood shelves** for further economy.
- **Fastest assembly** of any shelving using just 3 basic parts. No tools needed. Saves 30% compared to clip or stud types, 85% compared to nut-and-bolt types. Easy to disassemble and move, too.



## CONVENTIONAL CLIP TYPE SHELVING

- **Sway braces required** for rigidity mean more assembly time; also, prevent double entry storage.
- **Clips required** to secure shelving. Does *not* provide full-width shelf reinforcement.
- **Extra reinforcements required** when shelves will be subjected to moderate or heavy loading. Difficult to install in the field.
- **Does not offer economy advantage** of accepting chipboard or plywood shelves.
- **Tools required for assembly;** and disassembly is just as time-consuming.

---

## CHOICE OF UPRIGHT STYLES

All Aurora Shelving units can be assembled with either "T" uprights (common post construction for adding more units) or "L" uprights (for row ends). Photos show Standard Shelving; this same concept applies to Library Shelving.



**"L" UPRIGHT.** Used to dress up ends of rows and eliminate the 1" overhang at each row end.

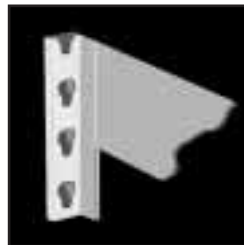

**"T" UPRIGHT.** Used to gain advantages of common-post construction and, with a modified panel, when wood or laminate end panels are desired.



# AURORA HEAVY DUTY SHELVING



## CLEAN LINE DESIGN

One piece back inserts between uprights and is held in place without holes or bolts - by its reverse flange edges.

---

## ADJUSTABLE REINFORCEMENTS

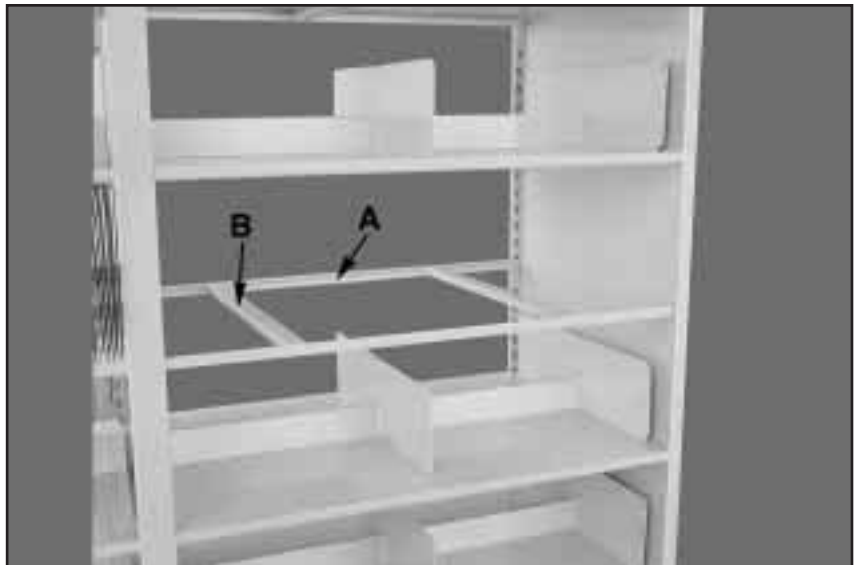

Shelf supports (part A above) give full width reinforcement, front and back, on every shelf. Adjustable reinforcements (Part B, above) should be positioned at specific points under the shelf.

# AURORA HEAVY DUTY SPECIFICATIONS

## **GENERAL:**

The shelving shall consist of three basic parts: uprights, shelves, and shelf supports; which are assembled without any loose nuts, bolts, or studs of any kind, without any sway braces or gussets, and without tools of any kind. There shall be no holes on exposed surfaces, except that the shelves have two holes for center stops. The front and back flange of the shelf shall be flush with the outside face of the post; and the back, where needed, will be flush with the outside face of the post. Shelves shall be adjustable on 1-1/2" centers.

## **OPEN UPRIGHTS:**

Shall consist of two 2" wide 18 gauge cold rolled steel posts rolled into a double wall "T" formation (or "L" formation at row ends, if desired), with keyhole slots on the inner wall only, on 1-1/2" centers. There shall be no holes in the face of the posts. The front and back posts shall be joined by welding three 3-1/8" high 18 gauge spacers to give the required upright depth and rigidity. "T" upright shall be used as a common upright between units.

## **CLOSED UPRIGHTS:**

Same specifications as open uprights, except three 18 gauge spacers are replaced by a welded 24 gauge closure sheet.

## **SHELVES:**

The shelf shall be formed of 18 gauge cold rolled steel with 5/8" flanges on all sides turned in front and back. Shelves are adjustable on 1-1/2" centers.

## **SHELF SUPPORTS:**

Shelf supports shall be formed of 14 gauge hot rolled, pickled steel to the specified width x 1-1/4" high with two additional flanges of 3/4" and 5/8", except that an ear 13/16" at each end shall be left unformed to accept two shoulder rivets. Rivets shall be 7/16" dia. at the head. Each ear of the shelf supports shall contain two solid core shoulder rivets spaced to set into keyhole slots on the inner wall of the uprights. Heavy duty 11 gauge supports are available.

## **BACK:**

The back shall be one piece formed of 22 gauge cold rolled steel without holes, and shall be held in place without fasteners of any kind, by its reverse flanged edges. The side edges of the back shall be formed in two reverse 90° bends, to give a flange of 7/16" and 3/16" wide. This flange shall fit around the post and shall hold the back in place by its flange between the shelf support, the notch in the shelf and the post.

## **SHELF REINFORCEMENTS:**

The shelf reinforcements shall be formed of 16 gauge cold rolled, commercial grade steel to the specified depth x 1 1/16" high and 1 3/18" wide. The shelf reinforcements shall be notched on each end to fit over the inside lip of the shelf supports.

## **FINISH:**

All surfaces are painted in a powder coated Gloss-Tek™ paint finish. Gloss-Tek™ is a raised surface finish that provides non-glare, fingerprint resistant durability. Colors may be selected from the Richards-Wilcox color selector or custom colors can be specified by the customer.

## **ESD PAINT:**

Aurora Shelving can be ordered with special ESD paint that dissipates electrostatic charge for use in applications in the telecommunications, electronics and semiconductor industries. Available in Black or Granite colors.

# AURORA HEAVY DUTY ACCESSORIES

ACCESSORIES to form an endless variety of arrangements for any heavy duty job... tool room and shop parts, storage, display units, vault and file storage



## HINGED DOORS

Set includes doors with one locking handle that is attached to right door.



## SLIDING DOORS

36" wide doors available in 72" 2-wide and 108" 3-wide sets, complete with top and bottom track, and one lock that locks all doors in a set. Sliding door contains pre-assembled rollers that give effortless operation, and cannot "clog".



## RETRACTABLE DOORS

Outfit 15" deep Aurora Shelving with retractable doors in widths of 36" or 42". Accuride® glides ensure smooth operation and optional locks provide selective security.



## ROLLOUT DRAWER

Rollout Drawers are available in either 36" or 42" widths with optional security locks. Designed to be used in 15" deep shelving applications, roll-out drawers can be configured with converter bars for letter-to-legal and front-to-back filing. Accuride® glides guarantee smooth movement. Double interlock secures the drawer, allowing only one drawer to be opened at a time.

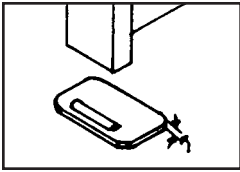

**SHIM (Optional)**

Compensates for unlevel floors, and protects tile from marring.

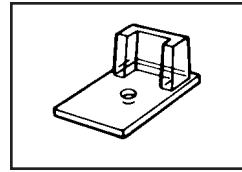

**PLASTIC FEET (Optional)**

Four for each "T" style upright (two for "L" uprights) fit into bottom of post to prevent damage to floors and carpets.

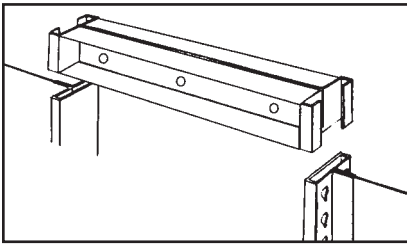

**AISLE TIE**

Position Aisle Tie in opposing T uprights overhead to secure shelving across an aisle. Available in three sizes: 36", 42" and 48" aisle widths.

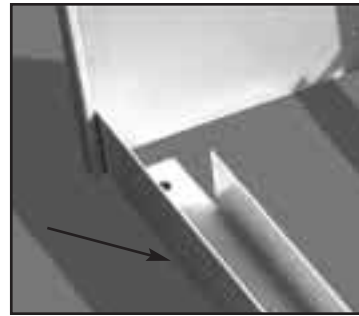

**QUIK-BASE™\***

**Quik-Base™** is a unique multi-functional component that combines the usefulness of a shelf support, front base and floor-anchoring device **all** in one. With **Quik-Base™**, all Aurora Shelving units will be secured in a much better, more positive manner.

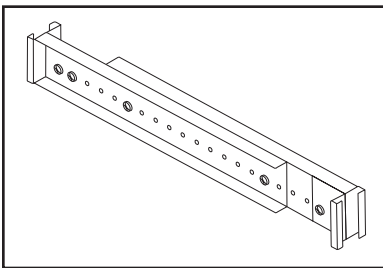

**ADJUSTABLE AISLE TIE**

The Adjustable Aisle Tie is used when an application calls for aisles that are not typical or standard width. This special Aisle Tie can

be adjusted on one-inch centers to change the size of an aisle. This flexibility can allow for an extra row of shelving or can accommodate design challenges such as working around a column.

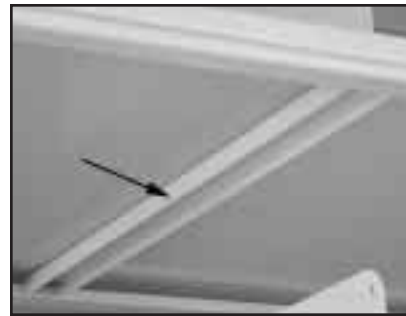

**SHELF REINFORCEMENT**

Used to prevent deflection of the shelf and evenly distributes the weight load.



**LABEL HOLDER**

(shelf length)  
Adhesive backing sticks to shelf. Six 6" labels included with each 34" holder.



**WALL ANCHOR (Optional)**

Ties shallow sections of shelving to wall. Adjustable to compensate for molding if necessary. One every other post is ample.

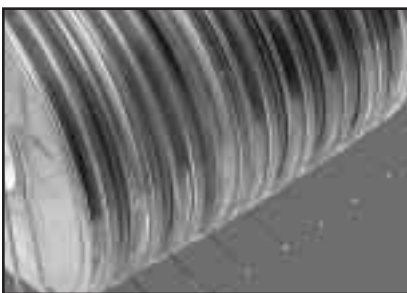

**REEL RACK**

Fits between shelf supports on 12" deep unit. No shelves required. Two sizes available. Wires 1-1/16" apart and 7" high (27 openings) designed to

hold 16 MM film. For computer tape reel storage, wires are spaced 1-1/2" apart (20 openings).



**U Clip (Optional)**

Grips open uprights together on back to back open shelving. Two recommended for each pair of back to back posts.



**CLOTHESPIN (Optional)**

Grips closed uprights together on back to back closed shelving. Use one in top of each pair of back to back posts.

# Steel Frames plus Wood Shelves – The *Economical* Answer for Light Loads

Moderate to lightweight loads can be stored efficiently and **economically** using Aurora Shelving uprights and shelf supports in combination with **plywood or chipboard shelves** which can be purchased locally. This is an excellent approach for reducing costs in storage of soft goods, lightweight parts and similar loads.

## Shelf Supports

STANDARD - 1 1/4" high, 14 Ga. and 11 Ga. (5/8" plywood and 3/4" plywood shelves shown)

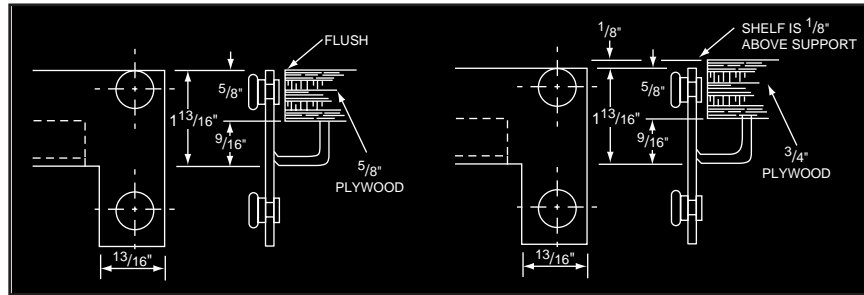

### SINGLE ROW SHELF SIZES

Nominal Depth	Actual Depth
12"	10 <sup>13/16</sup> "
15"	13 <sup>13/16</sup> "
18"	16 <sup>13/16</sup> "
24"	22 <sup>13/16</sup> "

Nominal Width	Actual Width
36"	35 <sup>3/4</sup> "
42"	41 <sup>3/4</sup> "
48"	47 <sup>3/4</sup> "

### DOUBLE ROW SHELF SIZES

Nominal Depth	Actual Depth
24"	22 <sup>7/8</sup> "
30"	28 <sup>7/8</sup> "
36"	34 <sup>7/8</sup> "
48"	46 <sup>7/8</sup> "

Nominal Width	Actual Width
36"	33 <sup>15/16</sup> "
42"	39 <sup>15/16</sup> "
48"	45 <sup>15/16</sup> "

Typical Plan View – Single Row Units with Plywood Shelves.

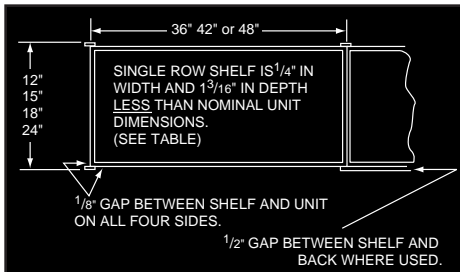

NOTE: On single row units where backs are used, back holders or clips are recommended.

Typical Plan View – Double Row Units, Back to Back with Plywood Shelves.

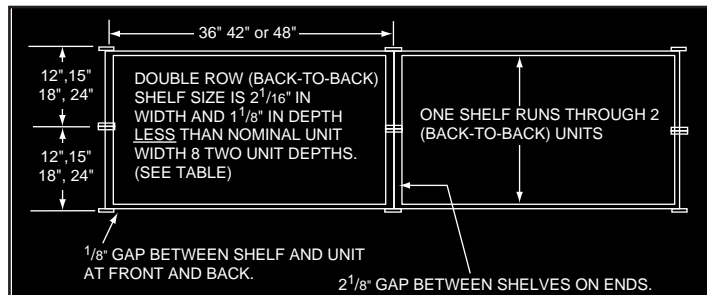

## Depth (side) Section of Two Back-to-Back Units (with one chipboard shelf through both units)

Tie back-to-back units together with "clothes pin" or U clips. These fasteners are recommended for each pair of uprights ordered.

Note that only three shelf supports are recommended for each shelf. Only one support is required in the shelf center where the back-to-back units meet providing another savings in materials. There is no loss in rigidity.

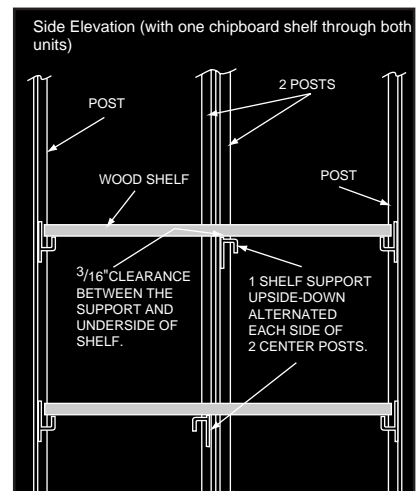

# ORDERING INFORMATION

## COMPARISON OF METHODS

Ordering by unit is simpler with less chance of error than by part. Using all "T" posts makes ordering simplest, and allows future additions to hook into existing shelving, but adds 2" to row length. Using "L" posts on end uprights omits the 2" overhang and allows an over-all row length equal to the exact width of the unit times the number of units. Also, the "L" posts provide dressier ends along aisles. Note that closed "L" uprights can be substituted for the open "L" uprights to give "finish panel" effect at ends of rows.

## TYPICAL REQUIREMENT

Top or "Plan" view shown. 5 sections of single row open shelving 36"W x 18"D x 88<sup>1</sup>/<sub>4</sub>"H, 7 shelves per section, arranged in 1-row of 3 sections and 1-row of 2 sections.

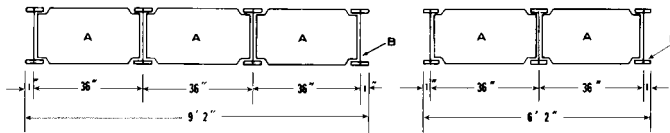
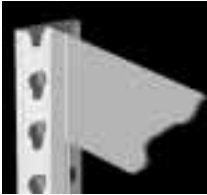

Using "T" Upright at End

### ORDER BY UNIT

- A** 5 ea. TQ1807T36 - 36"w x 18"d x 88<sup>1</sup>/<sub>4</sub>"h open shelving sections, 7 shelves.
- B** 2 ea. 18880T- 18"d x 88<sup>1</sup>/<sub>4</sub>"h open uprights, for end of rows.

### ORDER BY PART

- 7 ea. 18880T - 18"d x 88<sup>1</sup>/<sub>4</sub>"h open uprights  
 35 ea. 3618T - 36"w x 18"d shelves  
 70 ea. 3614S - 36"w shelf supports

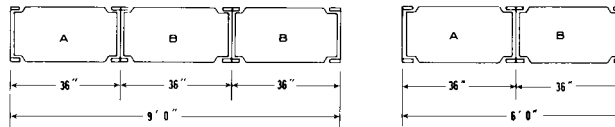

### ORDER BY UNIT

- A** 2 ea. TQ1807L36 - 36"w x 18"d x 88<sup>1</sup>/<sub>4</sub>"h open shelving sections, 7 shelves, ("L" Posts)
- B** 3 ea. TQ1807T36 - 36"w x 18"d x 88<sup>1</sup>/<sub>4</sub>"h open shelving sections, 7 shelves, ("T" Posts)

### ORDER BY PART

- 4 ea. 18880L - 18"d x 88<sup>1</sup>/<sub>4</sub>"h open uprights ("L" Posts)  
 3 ea. 18880T - 18"d x 88<sup>1</sup>/<sub>4</sub>"h open uprights ("T" Posts)  
 35 ea. 3618T - 36"w x 18"d shelves  
 70 ea. 3614S - 36"w shelf supports

## IMPORTANT DIMENSIONS

### FRONT VIEW (ELEVATION)

"T" POST CONSTRUCTION

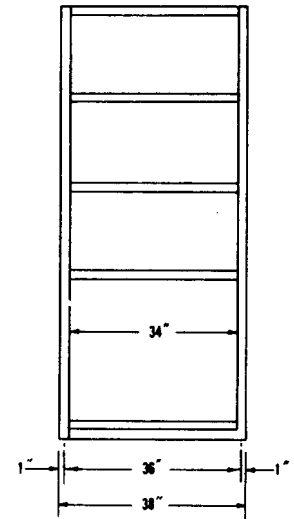

"L" POST CONSTRUCTION

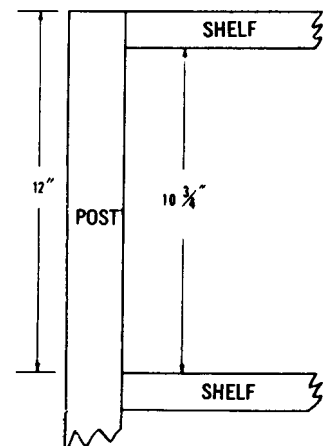
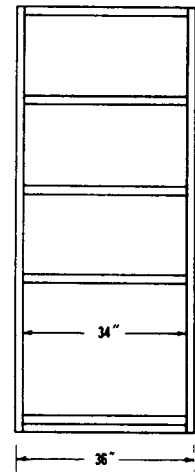

Deduct 1<sup>1</sup>/<sub>4</sub>" shelf flange from shelf centers to compute clear opening.

# AURORA LIBRARY SHELVING

## THE IDEAL CHOICE FOR CORPORATE, PROFESSIONAL AND PUBLIC LIBRARIES

Today's professional library must be well-planned, multi-functional, space efficient and have an aesthetic appeal that blends compatibly with existing decor. The incredible flexibility of the Aurora Shelving design concept has made Aurora Library Shelving the system of choice for many progressive libraries in both the public and private sector. Architects and

designers appreciate the ease with which Aurora Library Shelving adapts to custom applications. Aurora Shelving Products also feature a line of elegant wood-clad library shelving, Wood-Tek, that is pictured in the illustrations below. Custom work surfaces can be added to complement any interior design. A full range of accessories is available to meet every functional requirement.



## AURORA LIBRARY SHELVING SELECTION GUIDE

**NOTE:** Part numbers are self-descriptive. Descriptions given here for illustrative purposes only.

choose from:	3 styles	21 sizes
	Open Closed Double Entry	<p><b>4 widths</b> 30", 36", 42", 48"</p> <p><b>9 depths</b> 9", 10", 12", 13", 16", 18", 20", 24", 26"</p> <p><b>8 heights</b> 40<sup>1</sup>/<sub>4</sub>", 64<sup>1</sup>/<sub>4</sub>", 76<sup>1</sup>/<sub>4</sub>", 85<sup>1</sup>/<sub>4</sub>", 88<sup>1</sup>/<sub>4</sub>", 97<sup>1</sup>/<sub>4</sub>", 100<sup>1</sup>/<sub>4</sub>", 121<sup>1</sup>/<sub>4</sub>"</p>

### TYPICAL REQUIREMENTS

Top or "Plan" views shown. 5 sections of double entry library shelving 36" wide x 18" deep x 88<sup>1</sup>/<sub>4</sub>" high, 8 shelves per section, arranged in 1 row of 3 sections and 1 row of 2 sections.

### "T" POST CONSTRUCTION

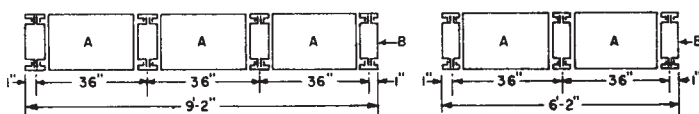

"A" 5 EA. L18D8T36 Add-On, 36" wide x 18" deep x 88<sup>1</sup>/<sub>4</sub>" high, 8 shelving sections, 8 shelves per section.

"B" 2 ea. 1888WT library upright.

### "L" POST CONSTRUCTION

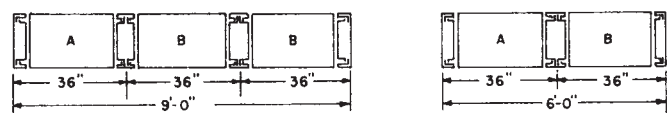

"A" 2 EA. L18D8L36, Starter 36" wide x 18" deep x 88<sup>1</sup>/<sub>4</sub>" high, 8 shelves.

"B" 3 ea. L18D8T36, Add-On 36" wide x 18" deep x 88<sup>1</sup>/<sub>4</sub>" high, 8 shelves per section.

# AURORA LIBRARY SHELVING SPECIFICATIONS

## GENERAL:

The shelving shall consist of the following basic parts: uprights, shelves, front bases, and shelf supports; which are assembled without any loose nuts, bolts, or studs of any kind; without any sway braces or gussets; and without tools of any kind. There shall be no holes on exposed surfaces. The front and back flange of the shelf shall be flush with the face of the post; and the back, where needed, will be flush with the face of the post. Shelves shall be adjustable on 1-1/2" centers.

## UPRIGHTS:

Shall consist of two 2" wide 18 gauge cold rolled steel posts rolled into a hollow "T" formation (or "L" formation at row ends) with keyhole slots on the inner back face on 1-1/2" centers. There shall be no holes in the face of the posts. The front and back posts shall be joined by two 24 gauge steel sheets full height of posts, forming a double wall construction. Shelf and support mounting and adjustment are semi-concealed in recessed channel of flush side wall at front and back. Common upright principle requires the use of only one "T" upright between units.

## SHELVES:

The shelf shall be formed of cold rolled steel with 5/8" flanges on all sides turned in front and back. Shelves are adjustable on 1-1/2" centers. 9", 10", and 12" shall be 22 gauge and 18", 20", 24" and 26" deep shelves shall be 18 gauge.

## SHELF SUPPORTS:

30" and 36" wide shelf supports shall be formed of 14 gauge, 42" and 48" wide formed of 11 gauge hot rolled, pickled steel to the specified width x 3/4" high with two additional flanges of 1-1/8" and 5/16", except that an ear 13/16" at each end shall be left unformed to accept two shoulder rivets. Rivets shall be 7/16" dia. at the head. Each ear of the shelf supports shall contain two solid core shoulder rivets spaced to set into keyhole slots on the inner face of the uprights.

## BACK:

The back shall be one piece formed of 22 gauge cold rolled steel, and shall be held in place without fasteners of any kind, by its reverse flanged edges. The side edges of the back shall be formed in two reverse 90° bends to give a flange of 3/8" and 3/16" wide. This flange shall fit around the post and shall hold the back in place by its flange between shelf support and the post.

## QUIK-BASE™\*:

**Quik-Base™** combines a shelf support, front base, and floor-anchoring device **all** in one. Units can be anchored through each end of a 16 gauge channel that allows the attachment points with the floor to be closer to the upright posts giving a much wider stance for a superior method of anchoring. Each end of the **Quik-Base™** shall have two solid core shoulder rivets spaced to set into keyhole slots on the inner face of the uprights.

## FINISH:

All surfaces are painted in a powder coated Gloss-Tek™ paint finish. Gloss-Tek™ is a raised surface finish that provides non-glare, fingerprint resistant durability. Colors may be selected from the Richards-Wilcox color selector or custom colors can be specified by the customer.

# AURORA LIBRARY SHELVING ACCESSORIES



## **BOOK SUPPORT**

Snaps in quickly and holds books firmly in place. Part No. 9WS

## **MAGAZINE DOOR**

Creates an attractive display area for magazines plus ample storage space for old issues. Door swings up easily for quick access to storage area. Part No. 3613MD



## **NEWSPAPER STICK HOLDER**

Newspaper display sticks furnished with the unit. Sticks can be removed and replaced easily.

Part No. 36 NS  
12 SHL  
12 SHR

## **REFERENCE SHELF**

A writing surface can be located in the shelving, which slides under a standard shelf. Part No. 3010RS for 9" and 10" deep shelving units and Part No. 3012RS for all others.



# AURORA SHELF FILING & X-RAY SHELVING

## AURORA SHELF FILING FOR EFFICIENT, ECONOMICAL STORAGE.

Gain all the advantages of open shelf filing...fast accessibility, greater visibility of filed materials, better use of space and overall economy...with unique, Aurora Shelf Filing.

### Only Aurora Shelving Units Offer You All These Features:

- Fast, easy, no-tool assembly by hand- no screws, bolts, clips or other fasteners needed for basic shelving units.
- Unmatched strength and rigidity *without* sway braces.
- Available in seven heights - 40<sup>1</sup>/<sub>4</sub>", 64<sup>1</sup>/<sub>4</sub>", 76<sup>1</sup>/<sub>4</sub>", 85<sup>1</sup>/<sub>4</sub>", 88<sup>1</sup>/<sub>4</sub>", 97<sup>1</sup>/<sub>4</sub>" 100<sup>1</sup>/<sub>4</sub>" and 121<sup>1</sup>/<sub>4</sub>". Eight depths 12", 13", 15" and 16" for single entry files, and 24", 26", 30" and 32" for double entry files; and four shelf widths 30", 36", 42" and 48".
- All surfaces are painted in a powder coated Gloss-Tek™ paint finish.
- Maximum visibility and access for both single entry and double entry installations.
- No worry about snagging folders on braces or fasteners.
- Slip-in dividers fit slotted shelves, can be easily changed or removed - excellent for all types of open filing.
- The truly simplified system- fewer parts than bracket type shelving.

### Foot for Foot, Aurora Shelf Units Are Your Best Shelf Filing Buy



Unique file dividers slip quickly, easily into slots; hold files upright, assuring neat appearance.



Reference shelf can be located under a standard shelf, provides a convenient writing surface. Slides out of sight when not in use. Can be used with all types of Aurora Shelving. (When used with 97<sup>1</sup>/<sub>4</sub>" or 76<sup>1</sup>/<sub>4</sub>" Shelf Filing, the bottom shelf should be lowered to the floor to maintain proper shelf spacing; however, special shelf supports with ears cut off must be used. When used with 88<sup>1</sup>/<sub>4</sub>" height, the bottom shelf is lowered to 2<sup>3</sup>/<sub>4</sub>" from floor.

## THE AURORA SHELVING DESIGN ASSURES FAST ASSEMBLY

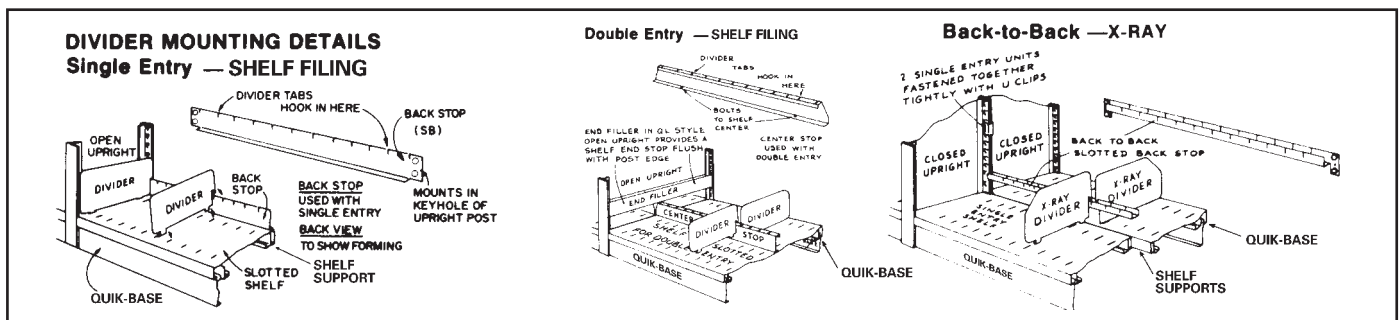

## AURORA SHELF FILING SELECTION GUIDE.

Only Aurora Shelf Filing offers such a wide selection of shelf sizes to meet all your requirements.

You can select from widths of 30", 36", 42" and 48" and depths of 12", 13", 15", 16", 24", 26" and 30" and 32". And for even greater versatility you can arrange the shelving as single entry, double entry, and back-to-back.

Select the best combination of Aurora Shelf Filing sizes and types to match your filing needs and available space. For estimated maximum shelf load limits call Customer Service.



---

## AURORA X-RAY SHELVING FOR UNMATCHED STRENGTH, EASY ACCESS

The Aurora Shelving design benefits are available for X-Ray storage. The complete lack of nuts, bolts, clips or sway braces eliminates the most common causes of snagged and torn X-Ray jackets. Fastest assembly is assured, and no tools are needed.

The superb strength means that Aurora Shelving easily withstands the heavy loading of X-Rays and maintains excellent rigidity.

Single and double entry configurations are available in 15", 18", 30", and 36" deep shelves in widths of 36", 42" and 48". For estimated maximum shelf load limits call Customer Service.



Typical 36" wide Aurora X-Ray section is 88<sup>1</sup>/<sub>4</sub>" high with six shelves and five openings. Standard assemblies include three file dividers for each opening and two reinforcements per shelf (except the top shelf).



Full height X-Ray Dividers  
Model 1616FHD (Single Entry)  
and 1616FHDDE (Double Entry)

### DIVIDER

Part No.	Size H. x D.
1310 FD	10" x 12 <sup>13</sup> / <sub>16</sub> "
1610 FD	10" x 15 <sup>13</sup> / <sub>16</sub> "
1616 FHD	16" x 15 <sup>13</sup> / <sub>16</sub> "
1616 FHDDE	16" x 15 <sup>13</sup> / <sub>16</sub> "

# AURORA SHELF FILING SPECIFICATIONS

## GENERAL:

The shelving shall consist of the following basic parts: uprights, shelves, front bases, and shelf supports, which are assembled without any loose nuts, bolts, or studs of any kind; without any sway braces or gussets; and without tools of any kind. Except for divider locating slots, there shall be no holes on exposed surfaces. The front and back flange of the shelf shall be flush with the face of the post; and the back, where needed, will be flush with the face of the post. Shelves shall be adjustable on 1-1/2" centers.

## OPEN UPRIGHTS:

Shall consist of two 2" wide 18 gauge cold rolled steel posts rolled into a double wall "T" formation (or "L" formation at row ends) with keyhole slots on the inner wall only, on 1-1/2" centers. There shall be no holes in the face of the posts. The front and back posts shall be joined by welding 3-1/8" high 18 gauge spacers to give the required upright depth and rigidity. Open uprights to be manufactured to heights specified. "T" upright shall be used as a common upright between units.

## CLOSED UPRIGHTS:

Same specifications as open uprights, except 18 gauge spacers are replaced by a welded 24 gauge closure sheet.

## SHELVES:

The shelf shall be formed of 18 gauge cold rolled steel with 5/8" flanges on all sides turned in front and back. Shelves are adjustable on 1-1/2" centers (22 gauge shelves also available). Single entry shelves shall have two rows, and double entry 4 rows of slots to accept file divider tabs.

## SHELF SUPPORTS:

Shelf supports 30" and 36" shall be formed of 14 gauge hot rolled, 42" and 48" shall be formed of 11 gauge hot rolled pickled steel to the specified width x 3/4" high with two additional flanges of 1-1/8" and 5/16", except that an ear 13/16" at each end shall be left unformed to accept two shoulder rivets. Rivets shall be 7/16" dia. at the head. Each ear of the shelf supports shall contain two solid core shoulder rivets spaced to set into keyhole slots on the inner wall of the uprights.

## BACK STOP:

The 16 gauge flanged back stop shall provide a 2-1/4" high back strip across the back edge of the single entry shelf. It shall attach to the inside face of the back posts on either side with tabs set into post key holes. The top edge shall be slotted on same spacing as the shelf to retain and stabilize the file dividers.

## BACK:

In addition to the backstops (where required), the back shall be one piece formed of 22 gauge cold rolled steel, and shall be held in place without fasteners of any kind, by its flanged edges. The side edges of the back shall be formed in one 90° square bend, and one 90° reverse bend to give a flange of 3/8" and 7/32" wide. This flange shall fit around the post and shall hold the back in place by its flange between shelf support and the post. The bottom edge of the back shall be formed in a 90° squared bend to give a flange 1/2" wide. The top shall have one 90° square bend 3/8" wide and one 90° reverse bend 1-1/8" wide. The back flange of the shelf shall be flush with the back.

## CENTER STOP:

The 24 gauge 2-1/4" high center stop flanged at bottom edge and box formed at top is bolted to and forms a divider along the center of the shelf to divide it for double entry filing on the same shelf. It is slotted with the same slot spacing as the shelf to retain and stabilize the opposing file dividers.

## QUIK-BASE™\*:

**Quik-Base™** combines a shelf support, front base, and floor-anchoring device **all** in one. Units can be anchored through each end of a 16 gauge channel that allows the attachment points with the floor to be closer to the upright posts giving a much wider stance for a superior method of anchoring. Each end of the **Quik-Base™** shall have two solid core shoulder rivets spaced to set into keyhole slots on the inner face of the uprights.

## FILE DIVIDERS:

18 gauge flat file dividers shall have 2 shelf tabs on the bottom edge and one hook tab on the back edge to locate and firmly support the dividers on the shelf.

## SHELF REINFORCEMENTS:

The shelf reinforcements shall be formed of 14 gauge hot rolled, pickled steel to the specified depth x 5/8" high and 1 1/4" wide. The shelf reinforcements shall be notched on each end to fit over the inside lip of the shelf supports.

## FINISH:

All surfaces are painted in a powder coated Gloss-Tek™ paint finish. Gloss-Tek™ is a raised surface finish that provides non-glare, fingerprint resistant durability. Colors may be selected from the Richards-Wilcox color selector or custom colors can be specified by the customer.

## ESD PAINT:

Aurora Shelving can be ordered with special ESD paint that dissipates electrostatic charge for use in applications in the telecommunications, electronics and semiconductor industries. Available in Black or Granite colors.

## AURORA SHELF FILING COMPONENTS

**UNIT** - Shelves are spaced on 10<sup>1</sup>/<sub>2</sub>" centers for standard filing with a 9<sup>3</sup>/<sub>4</sub>" clear opening and are adjustable on 1<sup>1</sup>/<sub>2</sub>" centers. A 12 inch shelf spacing is required for a reference shelf. Units that are 76<sup>1</sup>/<sub>4</sub>" and 97<sup>1</sup>/<sub>4</sub>" in height use two single rivet supports when a reference shelf is part of the unit and are standard in 64<sup>1</sup>/<sub>4</sub>" high units. In 76<sup>1</sup>/<sub>4</sub>" and 97<sup>1</sup>/<sub>4</sub>" high units start building shelves at 2<sup>3</sup>/<sub>4</sub>" from floor and at 4<sup>1</sup>/<sub>4</sub>" in 88<sup>1</sup>/<sub>4</sub>" high units.

**QUIK-BASE™** - Comes in 2<sup>3</sup>/<sub>4</sub>" and 4<sup>1</sup>/<sub>4</sub>" heights.

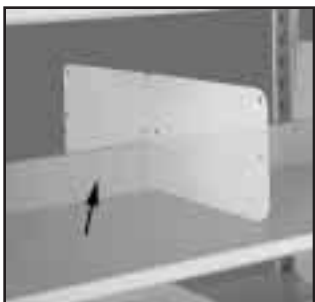
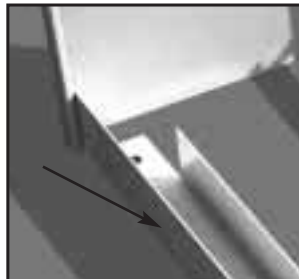

**SLOTTED BACK STOP** - Used in single entry units with tabs going into first and second full keyholes above the shelf.

**CENTER STOP** - Used in double entry units and is fastened to shelves with nuts and bolts. Finger tighten first. Put in a couple of dividers and adjust center stop so dividers are straight, then tighten nuts and bolts.

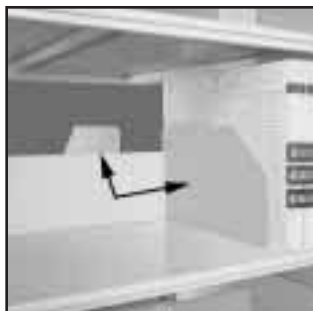

**FILE DIVIDERS** - Install by putting bottom shoe tab into front shelf slot then lower back tab into slot of center or back stop and bottom tab into back slot of shelf. One file divider is used on each far end of shelf and the rest may be adjusted as needed.

**REINFORCEMENTS** - Install before placing shelf over supports. Hook reinforcements over support flanges about 8" in from the end of support.



Use wall ties and **Quik-Base™** to fasten units to walls and floors. Aisle ties are used to anchor multiple units to each other. Floor shims must be used for leveling. These items are available in current price list.

## FLOOR LOADING

If the installation is above the ground floor, consider submitting the floor load to a structural engineer for approval.

### FLOOR LOADING CALCULATIONS:

- Weigh 10" of media, 10 times for the average weight of the media per filing inch.
- Multiply the average weight per filing inch by the total room filing capacity.
- Add the equipment weight.
- Submit a drawing along with the estimated weight to the structural engineer for approval.

### MEDIA WEIGHT:

Letter Size Folders	2.5 lbs. per filing inch
Legal Size Folders	3 lbs. per filing inch
X-Ray Jackets	8 lbs. per filing inch
Books	3.5 lbs. per filing inch

## SHELVING ADJUSTABILITY

Shelves are adjustable on 1.5 inch increments.

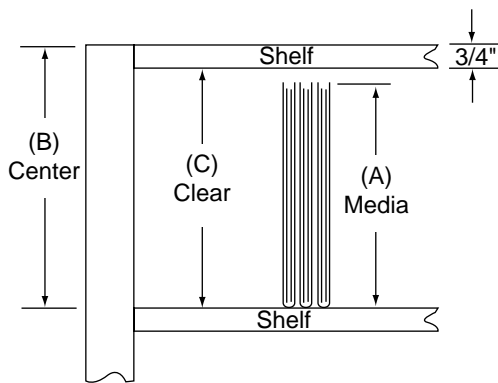

MEDIA SIZES		
Media (A)	Height	
Fiche, Film .....	4.25"	
Cards .....	5.25"	
Video Tapes .....	8.0"	
Folders .....	9.5" & 10"	
Books .....	10.0"	
Binders .....	11.5"	
X-Rays .....	15.0"	
CENTERS AND CLEAR DIMENSIONS		
Center (B)	Clear Opening	
	Thin Shelf (C)	Standard Quik-Loc® (C)
6.0"	5.25"	4.75"
7.5"	6.75"	6.25"
9.0"	8.25"	7.75"
10.5"	9.75"	9.25"
12.0"	11.25"	10.75"
13.5"	12.75"	12.25"
15.0"	14.25"	13.75"
16.5"	15.75"	15.25"

## FILING INCH / SQUARE FOOTAGE COMPARISON CHART

<b>Lateral Files</b>				
<b>Unit</b>	<b>Size</b>	<b>L.F.I.</b>	<b>Square Ft. Usage</b>	
2 Drawer	36"W	66" L.F.I.	36W = 8.25	
2 Drawer	42"W	78" L.F.I.	42 W = 9.63	
3 Drawer	36"W	99" L.F.I.		
3 Drawer	42"W	117" L.F.I.		
4 Drawer	36"W	132" L.F.I.	NOTE: Square	
4 Drawer	42"W	156" L.F.I.	Footage Usage	
5 Drawer	36"W	165" L.F.I.	includes Drawer	
5 Drawer	42"W	195" L.F.I.	pull out.	
<b>Vertical Files</b>				
<b>Unit</b>	<b>Size</b>	<b>L.F.I.</b>	<b>Square Ft. Usage</b>	
2 Drawer	Letter or Legal	50" L.F.I.	Letter =6.25 Legal =7.50	
3 Drawer	Letter or Legal	75" L.F.I.		
4 Drawer	Letter or Legal	100" L.F.I.		
5 Drawer	Letter or Legal	125" L.F.I.		
<b>Shelf Files w/Doors</b>				
<b>Unit</b>	<b>Size</b>	<b>L.F.I.</b>	<b>Square Ft. Usage</b>	
5 Tier	36"W	170 L.F.I.	Letter =3.33 Legal =4.00	
6 Tier	36"W	204 L.F.I.		
7 Tier	36"W	238 L.F.I.		
<b>4 - Post Shelving Systems</b>				
<b>Unit</b>	<b>Size</b>	<b>L.F.I.</b>	<b>Square Ft. Usage</b>	
			<b>Letter</b>	<b>Legal</b>
6 Opening	36"W	204 L.F.I.	3.0	3.75
6 Opening	42"W	240 L.F.I.	3.5	4.37
6 Opening	48"W	276 L.F.I.	4.0	5.0
7 Opening	36"W	238 L.F.I.	3.0	3.75
7 Opening	42"W	280 L.F.I.	3.5	4.37
7 Opening	48"W	322 L.F.I.	4.0	5.0
8 Opening	36"W	272 L.F.I.	3.0	3.75
8 Opening	42"W	320 L.F.I.	3.5	4.37
8 Opening	48"W	368 L.F.I.	4.0	5.0



600 South Lake Street • Aurora, Illinois 60506 • 800-277-1699 • 630-897-6951 • Fax 630-897-6994  
[www.aurorashelving.com](http://www.aurorashelving.com)